

AKKU-UMREIFUNGSGERÄT  
OR-T 260



Universal application  
PP & PET / 13–16 mm

# PACKAGE CONTENT



# OPERATION





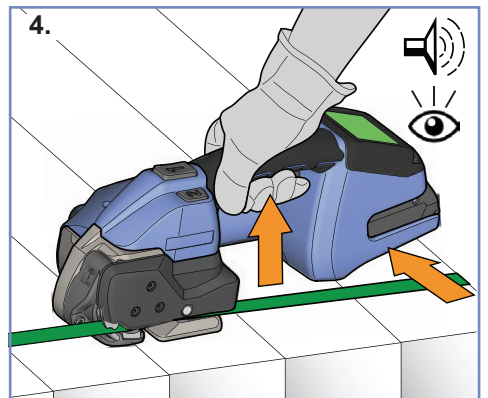
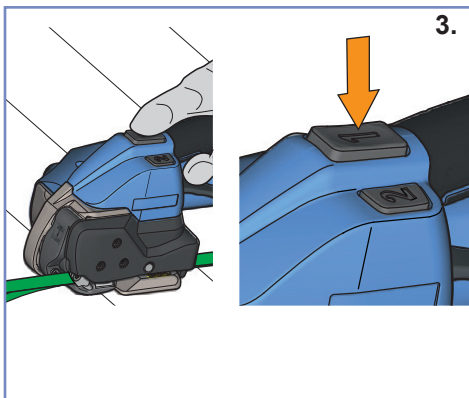
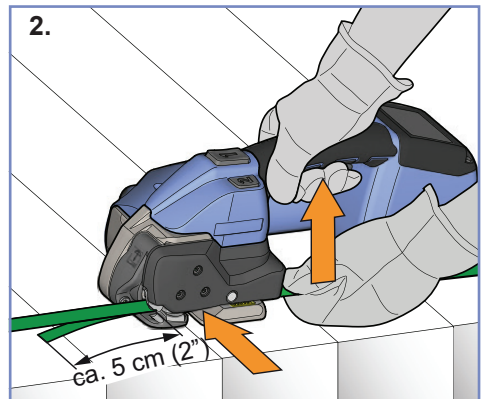
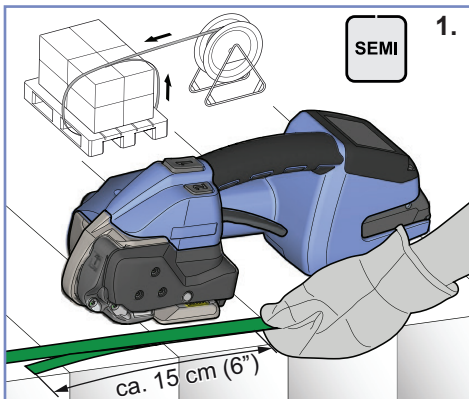

For safety regulations,  
refer to operating  
instructions!

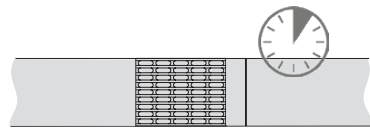
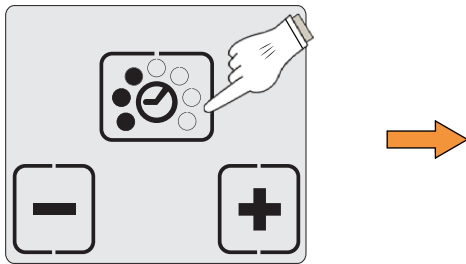
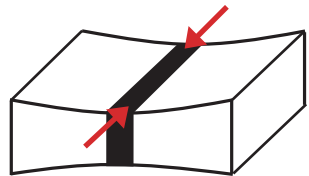
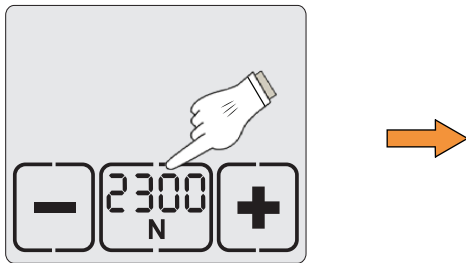
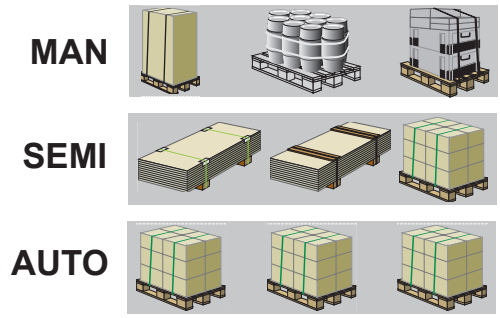
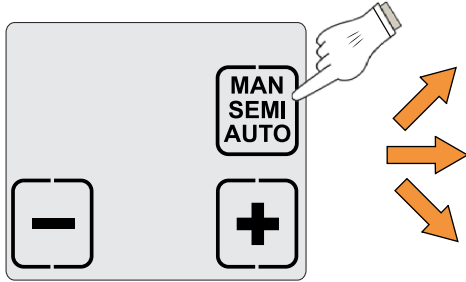
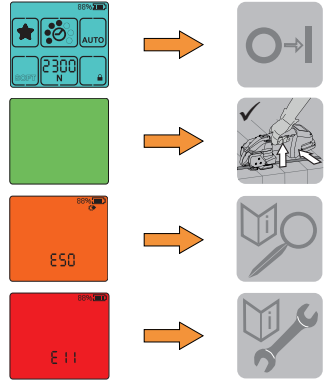
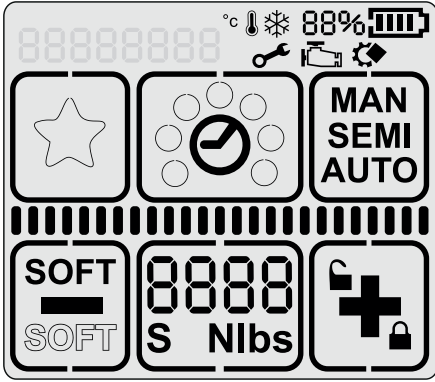

# USER INTERFACE

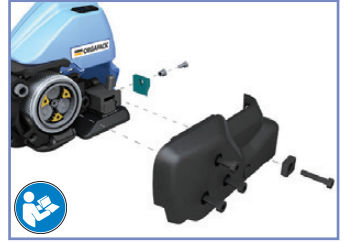

## CLEANING/REPLACING WEAR PARTS



## ACCESSORIES

